

**FARMERS MARKET**  
**SUNSHADE CALL-FOR-ART**  
DOWNTOWN DEVELOPMENT AUTHORITY  
ANN ARBOR, MICHIGAN

**SITE PLAN**

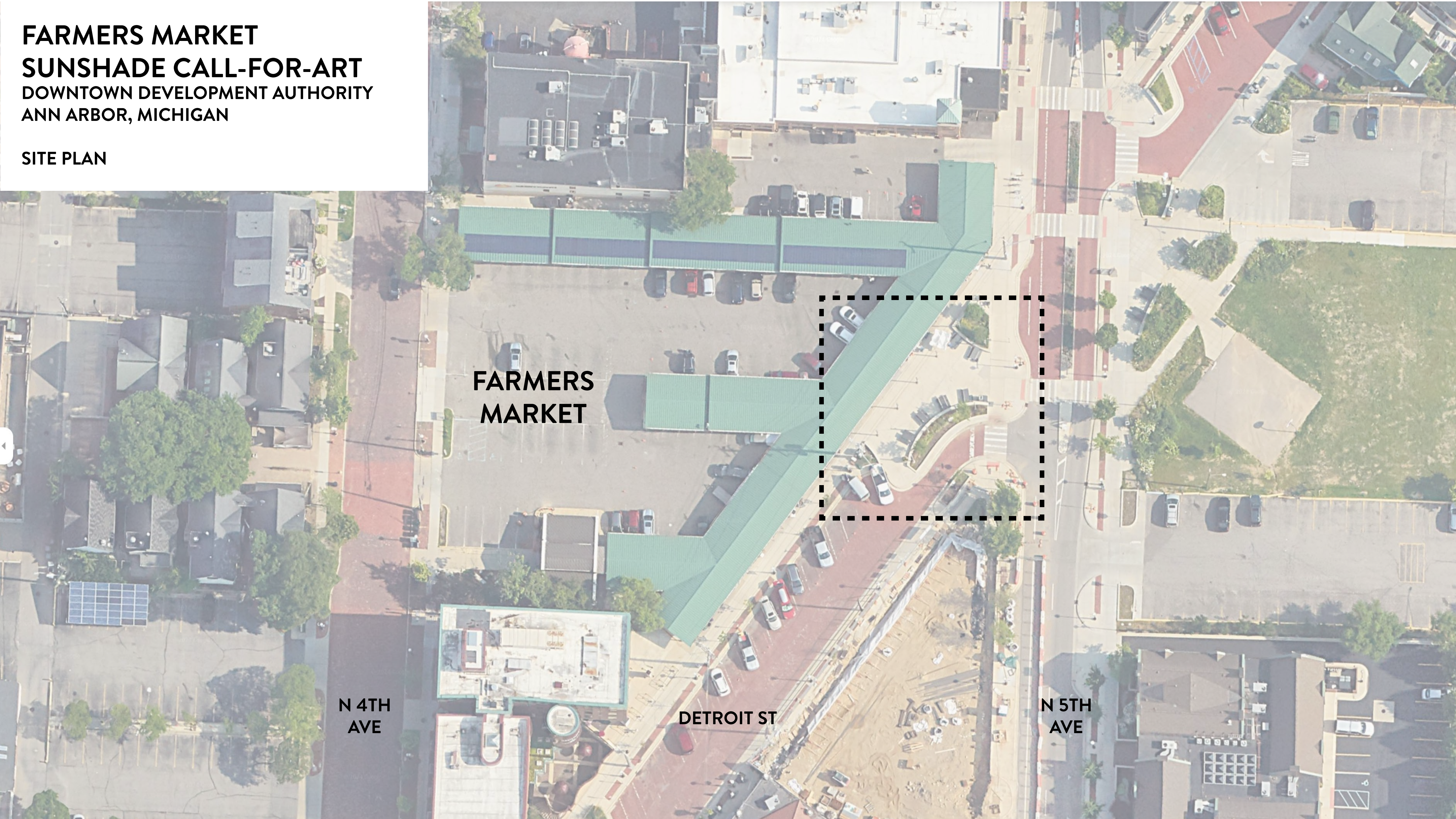

**FARMERS  
MARKET**

**N 4TH  
AVE**

**DETROIT ST**

**N 5TH  
AVE**

**FARMERS MARKET**  
**SUNSHADE CALL-FOR-ART**  
DOWNTOWN DEVELOPMENT AUTHORITY  
ANN ARBOR, MICHIGAN

SITE PHOTO



**FARMERS MARKET  
SUNSHADE CALL-FOR-ART  
DOWNTOWN DEVELOPMENT AUTHORITY  
ANN ARBOR, MICHIGAN**

**SITE PHOTO**



**FARMERS MARKET  
SUNSHADE CALL-FOR-ART  
DOWNTOWN DEVELOPMENT AUTHORITY  
ANN ARBOR, MICHIGAN**

**SITE PHOTO + DETAIL**



**FARMERS MARKET  
SUNSHADE CALL-FOR-ART  
DOWNTOWN DEVELOPMENT AUTHORITY  
ANN ARBOR, MICHIGAN**

**SITE PHOTO: NIGHT**



**FARMERS MARKET  
SUNSHADE CALL-FOR-ART  
DOWNTOWN DEVELOPMENT AUTHORITY  
ANN ARBOR, MICHIGAN**

**SITE PHOTO: NIGHT**





**FARMERS MARKET  
SUNSHADE CALL-FOR-ART  
DOWNTOWN DEVELOPMENT AUTHORITY  
ANN ARBOR, MICHIGAN**

**SITE PLAN: MEASUREMENTS BETWEEN THE  
CENTERS OF EACH POLE**

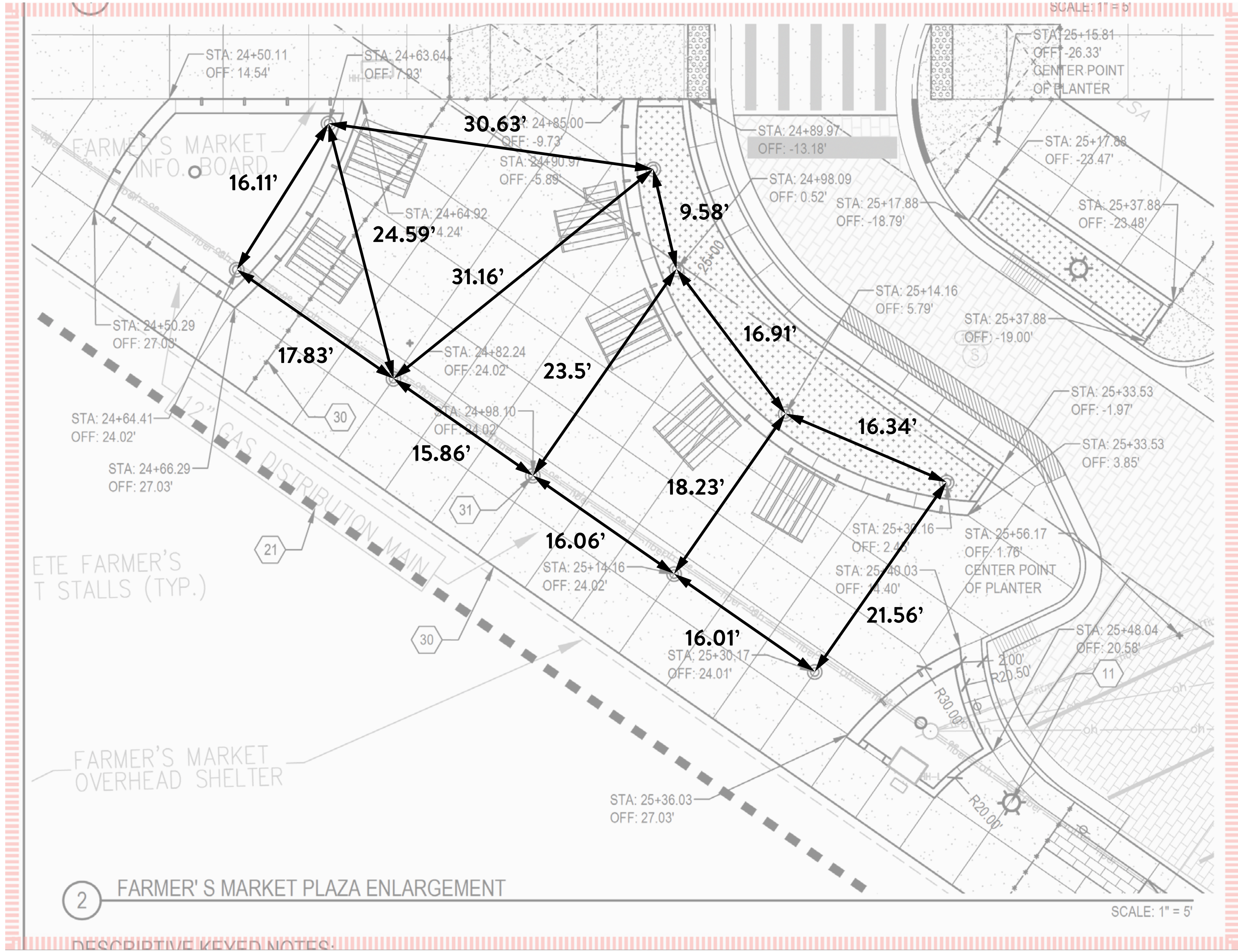



# FARMERS MARKET

## SUNSHADE CALL-FOR-ART

DOWNTOWN DEVELOPMENT AUTHORITY  
ANN ARBOR, MICHIGAN

### POLE SECTION + ELEVATION

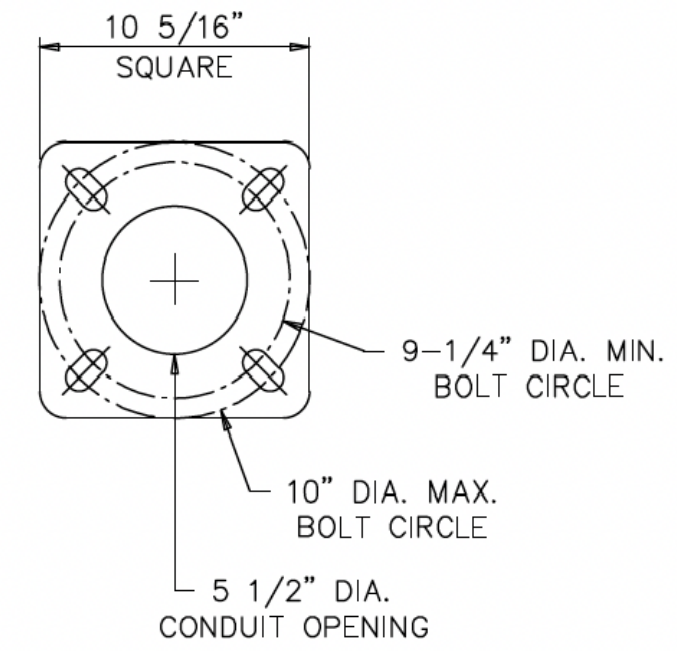
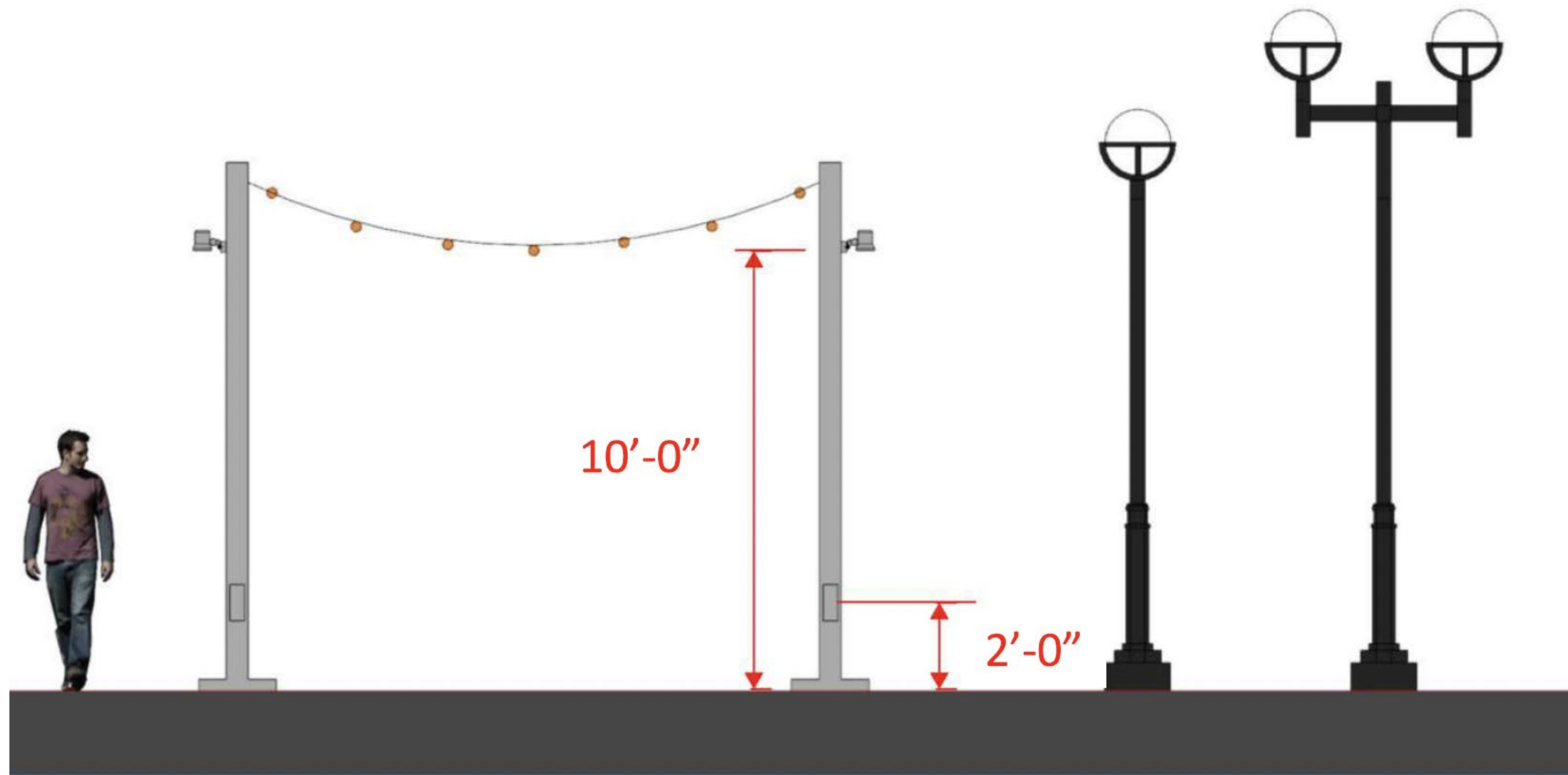

**BASE DETAIL**  
(NUT COVERS NOT SHOWN)

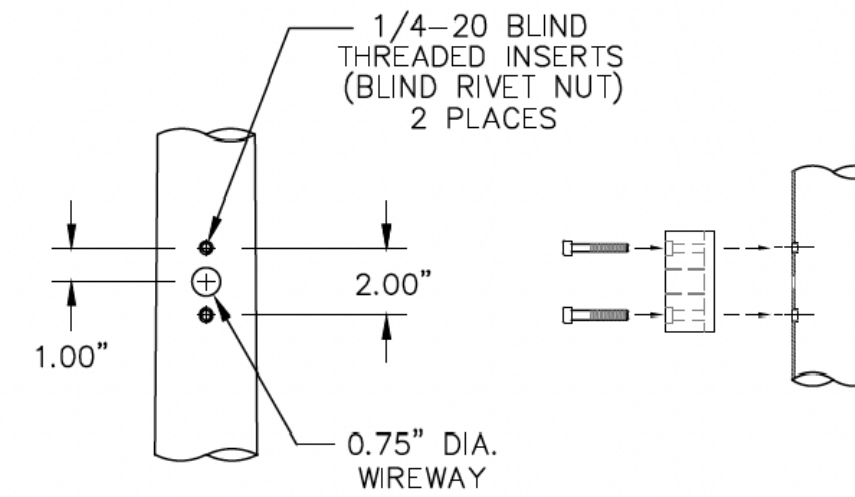
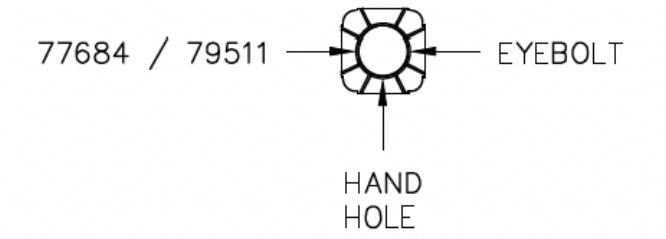

**79511**  
INSERT/WIREWAY  
DETAIL

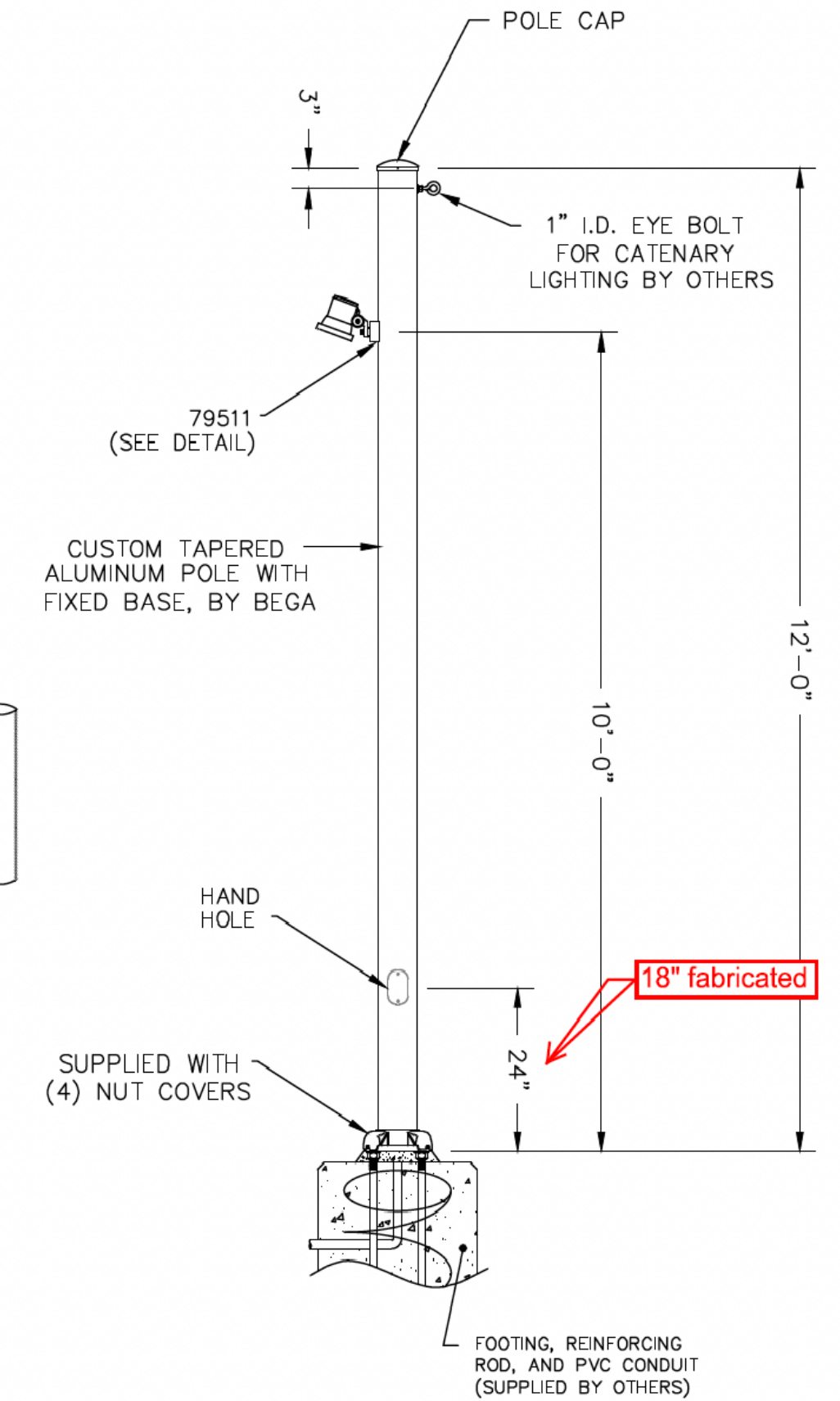

**NOTES:**

- LUMINAIRE # 77684 – SEE SPECIFICATIONS;
  - 120-277V ELECTRONIC (0-10V) DIMMING DRIVER
  - 13.9W LED ARRAY (16 TOTAL SYSTEM WATTS)
- BEGA POLE MOUNT ACCESSORY 79511
- CUSTOM POLE FOR USE WITH CATENARY SYSTEM BY OTHERS  
VALMONT MODEL 120060608S4H (DWG NO. A8926)  
POLE SUPPLIED WITH (4) 1"-8 X 36" LONG ANCHOR BOLTS  
POLE IS RATED FOR 90MPH PER AASHTO
- COLOR: BEGA SILVER